

Specifically
designed for your
high-precision
material handling.

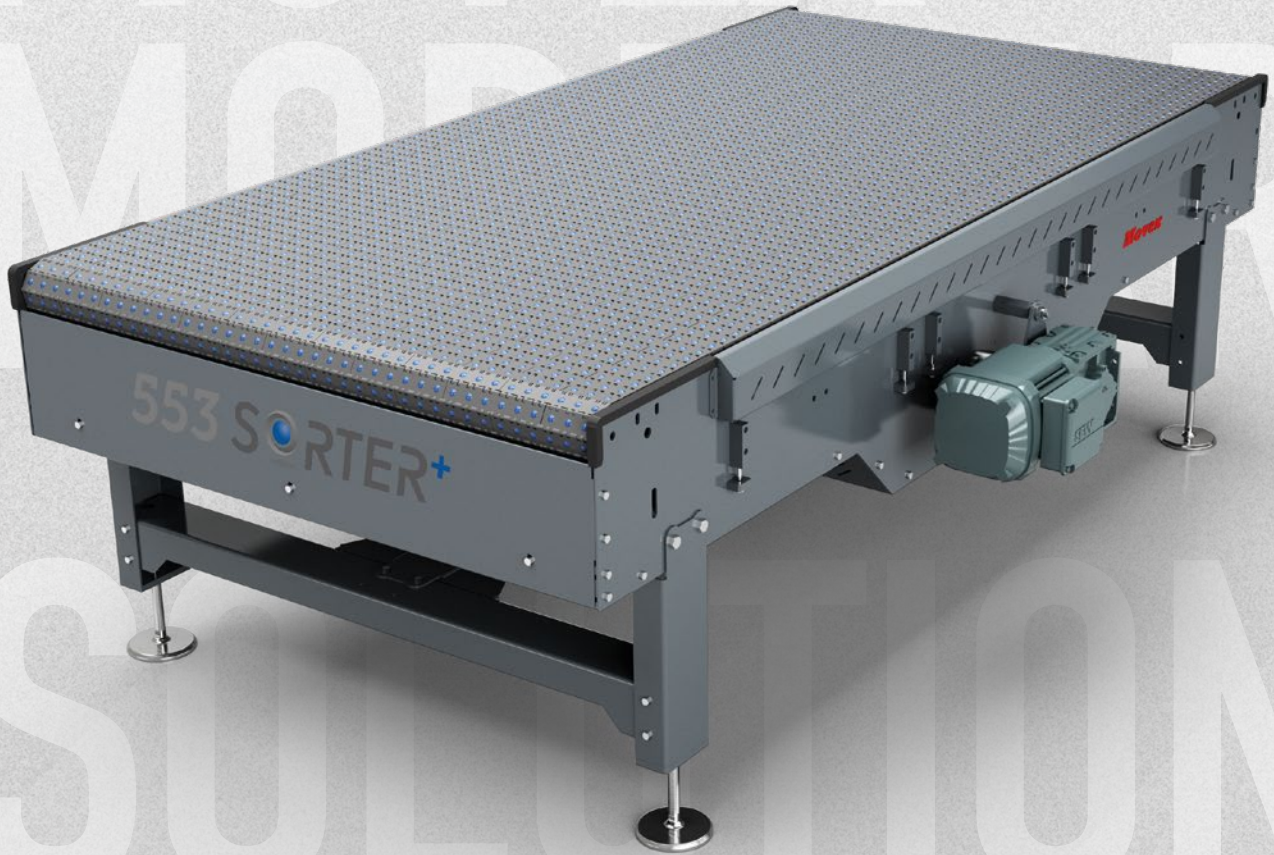

553 SORTER⁺

MULTIDIRECTIONAL CONVEYOR

Movex[®]
www.movexii.com

553 SORTER+

The new **Movex® 553 Sorter+** is a multidirectional conveyor, equipped with the unique modular belt 553 FlexTop with self-locking spheres. Specifically designed for high-precision material handling, it is suitable for several applications, such as logistic centers, packaging stations (food and beverage), and the corrugated industries. It can be easily integrated into existing systems.

The new design has improved the performance of the conveyor, making it even more effective and customizable to meet the needs of the most demanding customers.

The 360° movement capability makes the belt suitable for diverting, rotating, accumulating, and accelerating applications while minimizing maintenance and downtime. The small pitch between the spheres (diameter 12.7 mm) allows for the transfer of every type of product and is ideal for small and light packages, unlike traditional roller conveyors.

The completely closed sliding belt surface is the perfect solution for carrying carton boxes, crates, cans and bottles, shrink-wrapped packaging, and any kind of polybag with top-accuracy package control.

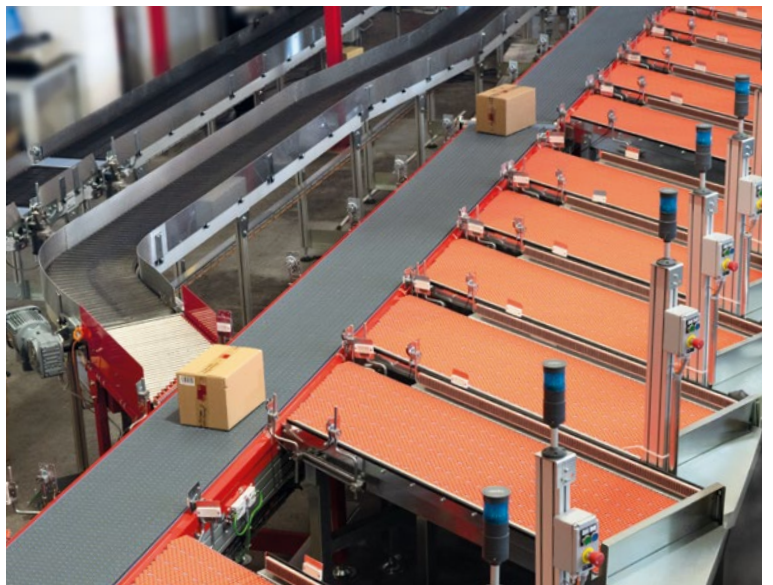
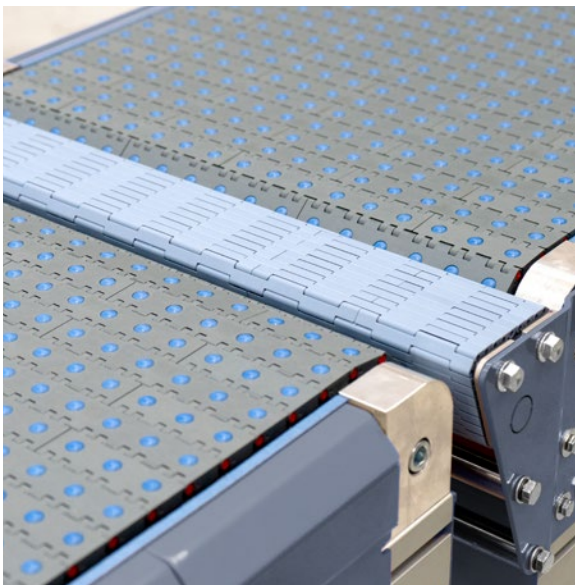

Top-Accuracy control

553 Sorter+ guarantees 360° freedom of movement.



Optimized system flexibility

553 Sorter+ is based and designed on your specific needs.



High spheres resistance

and high movement precision.



Superior Durability

and high working load guaranteed for all versions available.



User-friendliness

Easy installation and interchangeability also in existing lines.



Quick maintenance

and reduced downtimes.

Versatility is the watchword

Available movement options

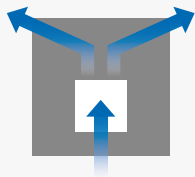

Diverter

Capable of moving your goods side to side (left and right).



Static turn

Capable of rotating statically your goods.

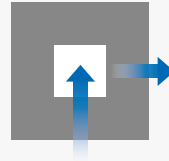

90° transfer

Capable of moving your goods at a 90° angle (left and right).

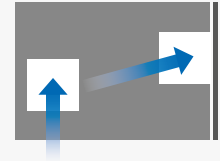

Aligner

Capable of moving your goods and aligning them with a lateral profile.

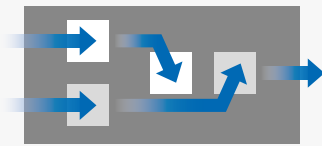

Merger

Capable of moving your goods and aligning them in a single row.

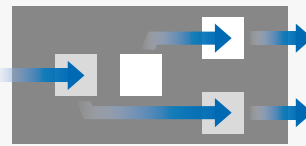

Diverger

Capable of moving your goods and dividing them in two rows.

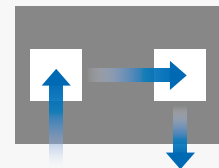

U-turn

Capable of making a U-turn with your goods.

Available on request

Ideal for several products and industries



These are just some of the products that can be handled with 553 Sorter+, its versatility allows to transport countless types of products and for several type of industries.

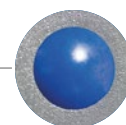

15 N
LOAD/SPHERE
Closed gap
PATENTED

Application example

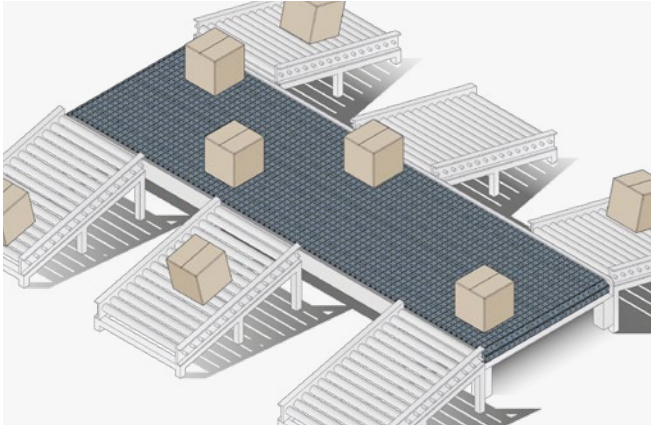

Automatic storage system

- Distribution system
- Sorting
- Lane divider
- Picking
- Merging
- Vision inspection systems

553 sorter+ is the right solution for align, reject, turn, divert, merge, rotate and separate various goods in more formats. Thanks to its versatility, it is applicable for many solutions, from straight to 90°, to “U turn”.

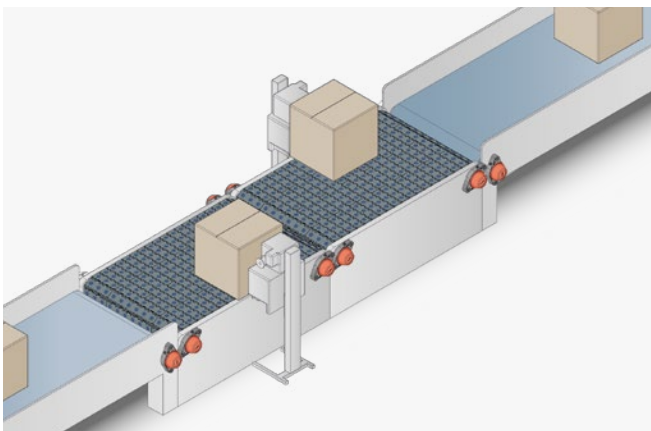

Product positioning

- Labelling
- Printing
- Reading Barcodes

553 sorter+ is the right solution for align, reject, turn, divert, rotate and separate various goods in more formats. Thanks to its versatility, it is applicable for many solutions.

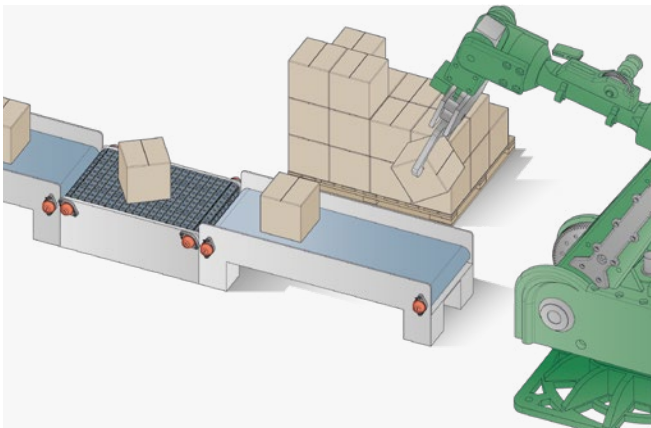

Product orientation

- Casing machines
- Palletizers

553 sorter+ is the good solution for palletizing layers: dynamic separation, alignment, rotation can be the alternative preparation with robot layer.

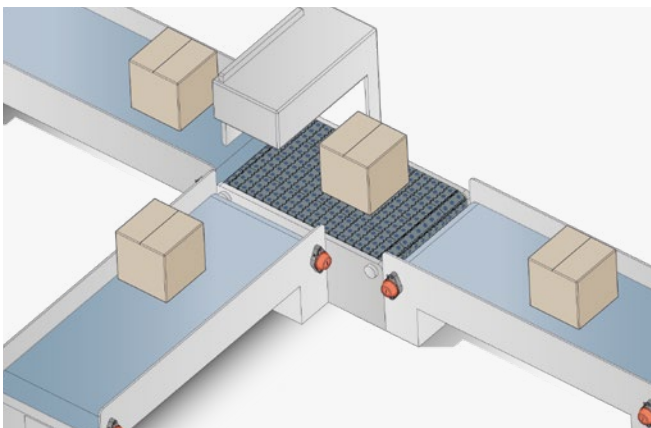

Reject station

- Inspection equipment
- Measuring devices

Intalling 553 sorter+ after checking stations is the proper solution for rejecting management, the machine can work both with stop/go 90° or 45° running.

☰ **Quote module** Page 11

+ **Accessories** Page 9/10



Floor supports



Gearmotors

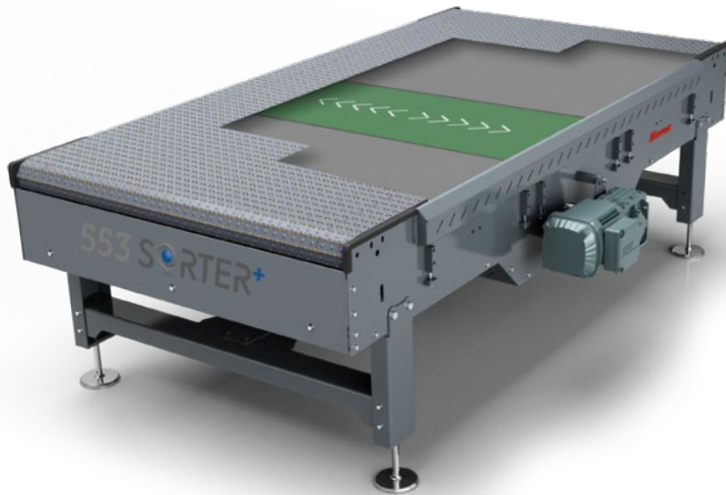

ZEROPRO ATP[®]
ACTIVE TRANSFER PLATE



TRY IT NOW!

Choose the smallest Active Transfer Plate available on the market and boost your line performance! Ask for more info!

■ Standard 553 Sorter+ Painted steel frame color RAL 7031 - Blue grey

Available movement options

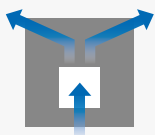

Diverter

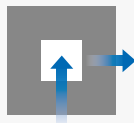

90° transfer

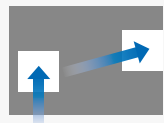

Aligner

553 Sorter⁺ Diverter version

These codes mean complete curve, except floor supports and gearmotors.

W Belt Width*	L Conveyor length*	Type	N° of diverter	Diverter type (see below for more specs)	Diverter width (Check the relation with L)	Frame material
533 (21")	1000 (39")	DI Diverter	1	RD Roller drive	350 (13.8")	PS Painted steel
686 (27")	1400 (55")			DD Master/slave Roller drive	500 (19.7")	SS Stainless steel
838 (33")	1800 (70")			DM Drum motor	600 (23.6")	
990 (39")				GB Gearbox		

Article-Nr. structure guide (Example) Select the different value to compose the Article-Nr

W0533

L01000

DI

1

RD

0350

PS

Diverter Power supply



RD Roller drive
24Vdc



Single motor
Up to 12Kg

DD Master/slave Roller drive
24Vdc



Dual motor
Up to 20Kg

DM Drum motor
380/400V



Single motor
Up to 50Kg

GB Gearbox
380/400V



Single motor
Up to 50Kg

RD and DD solutions include the control system.

*Different lengths, widths and configurations are available on request, please contact your sales representative.



☰ **Quote module** Page 11

+ **Accessories** Page 9/10



Floor supports



Gearmotors

ZEROPRO ATP®
ACTIVE TRANSFER PLATE



TRY IT NOW!

Choose the smallest Active Transfer Plate available on the market and boost your line performance! Ask for more info!

■ Standard 553 Sorter+ Painted steel frame color RAL 7031 - Blue grey

Available movement options

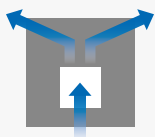

Diverter

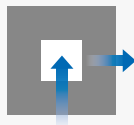

90° transfer

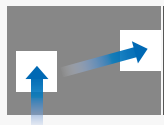

Aligner

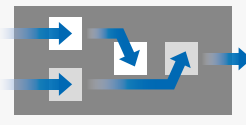

Merger

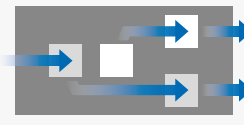

Diverger

On request

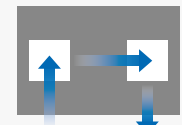

U-turn

553 Sorter+ Diverter version

These codes mean complete curve, except floor supports and gearmotors.

W Belt Width*	L Conveyor length*	Type	N° of diverter	Diverter type (see below for more specs)	Diverter width (Check the relation with L)	Frame material
533 (21")	1200 (47.2")	DI Diverter	2	RD Roller drive	350 (13.8")	PS Painted steel
686 (27")	1500 (59")			DD Master/slave Roller drive	500 (19.7")	SS Stainless steel
838 (33")	1800 (70")			DM Drum motor	600 (23.6")	
990 (39")				GB Gearbox		

Article-Nr. structure guide (Example) Select the different value to compose the Article-Nr

W0533

L01200

DI

2

RD

0350

PS

Diverter Power supply



RD Roller drive
24Vdc



Single motor
Up to 12Kg

DD Master/slave Roller drive
24Vdc



Dual motor
Up to 20Kg

DM Drum motor
380/400V



Single motor
Up to 50Kg

GB Gearbox
380/400V



Single motor
Up to 50Kg

RD and DD solutions include the control system.

*Different lengths, widths and configurations are available on request, please contact your sales representative.

☰ **Quote module** Page 11

+ **Accessories** Page 9/10



Floor supports



Gearmotors

ZEROPRO ATP®
ACTIVE TRANSFER PLATE



TRY IT NOW!

Choose the smallest Active Transfer Plate available on the market and boost your line performance! Ask for more info!

■ Standard 553 Sorter+ Painted steel frame color RAL 7031 - Blue grey

Available movement options

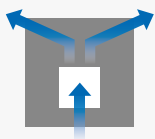

Diverter

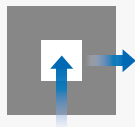

90° transfer

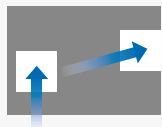

Aligner

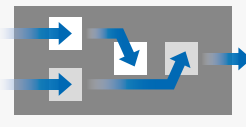

Merger

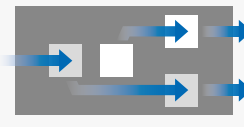

Diverter

On request

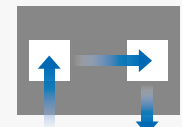

U-turn

553 Sorter+ Diverter version

These codes mean complete curve, except floor supports and gearmotors.

W Belt Width*	L Conveyor length*	Type	N° of diverter	Diverter type (see below for more specs)	Diverter width (Check the relation with L)	Frame material
533 (21")	1800 (70")	DI Diverter	3	RD Roller drive	350 (13.8")	PS Painted steel
686 (27")	2100 (86.7")			DD Master/slave Roller drive	500 (19.7")	SS Stainless steel
838 (33")	2400 (94.5")			DM Drum motor	600 (23.6")	
990 (39")				GB Gearbox		

Article-Nr. structure guide (Example) Select the different value to compose the Article-Nr

W0533

L01800

DI

3

RD

0350

PS

Diverter Power supply

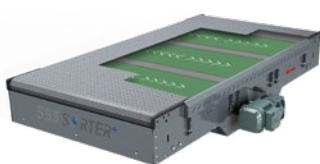

RD Roller drive
24Vdc



Single motor
Up to 12Kg

DD Master/slave Roller drive
24Vdc



Dual motor
Up to 20Kg

DM Drum motor
380/400V



Single motor
Up to 50Kg

GB Gearbox
380/400V



Single motor
Up to 50Kg

RD and DD solutions include the control system.

*Different lengths, widths and configurations are available on request, please contact your sales representative.

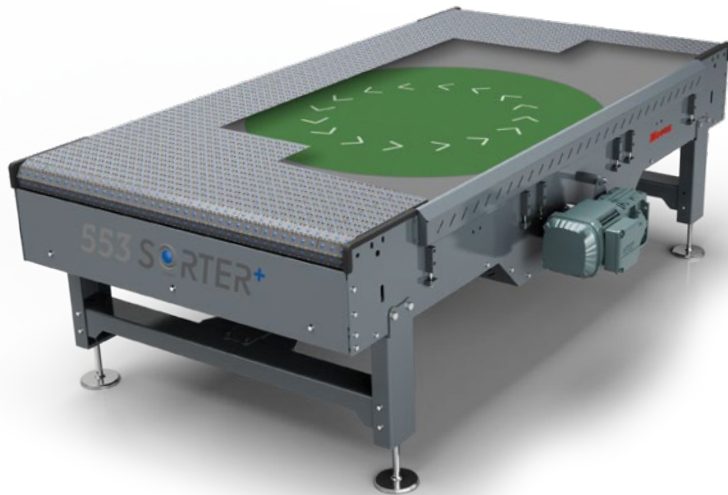

☰ **Quote module** Page 11

+ **Accessories** Page 9/10



Floor supports



Gearmotors

ZEROPRO[®] ATP[®]
ACTIVE TRANSFER PLATE



TRY IT NOW!

Choose the smallest Active Transfer Plate available on the market and boost your line performance! Ask for more info!

■ Standard 553 Sorter+ Painted steel frame color RAL 7031 - Blue grey

Available movement options



Static turn

553 Sorter⁺ Static turn version

These codes mean complete curve, except floor supports and gearmotors.

W Belt Width*	L Conveyor length*	Type	N° of diverter	Diverter type (see below for more specs)	Turning Table Ø (Check the relation with L)	Frame material
533 (21")	1200 (47")	ST Static turn	1	GB Gearbox	400 (15.8")	PS Painted steel
686 (27")	1800 (71")				600 (23.6")	SS Stainless steel
838 (33")					800 (31.5")	
990 (39")						

Article-Nr. structure guide (Example) Select the different value to compose the Article-Nr

W0533

L01200

ST

1

GB

0400

PS

Static turn Power supply

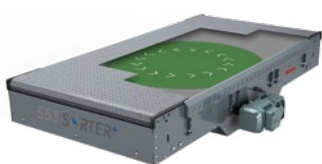

GB Gearbox
380/400V



Single motor
Up to 50Kg

*Different lengths, widths and configurations are available on request, please contact your sales representative.

Floor support with leveling feet



Conveyor Width	Painted Steel Floor support
533 (21")	W0533HS
686 (27")	W0686HS
838 (33")	W0838HS
990 (39")	W0990HS

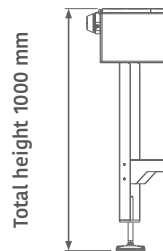

- Stainless steel AISI 304 floor supports available on request
- Single or double floor fixation levellers available on request
- Customizable height and specifications

For different heights or custom specification please contact your sales representative.

Gearmotor

SEW



- Foodgrade oil
- Type WA30 DRN71M4
- Internal shaft position (no cable supplied)

Article Nr.	Power
M090-S/IM	0,37 kW

BONFIGLIOLI



- Type BN 71B 4 B14 KW 0,37
- Internal shaft position (no cable supplied)

Article Nr.	Power
M090L-S/IM	0,37 kW

For different gearmotors please contact your sales representative.

SEW and BONFIGLIOLI are believed to be the trademarks and/or trade names of their respective owners and are not owned or controlled by Movex.

Slide chute



In option, we can provide sliders to any diverting point: the slide could be made of painted steel or stainless steel, ensuring compatibility with your operational requirements and environmental conditions.

Contact our expert for more information.

Low back pressure chute

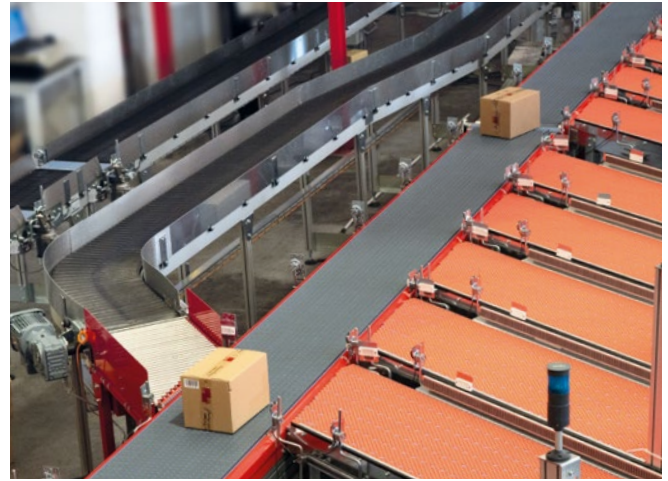

In option, we can provide straight chute or angled chute with our Low back pressure modular belt 551 Pro LBP, designed to handle high-speed accumulation with minimal product damage.

Contact our expert for more information.

Custom personalization

The **Movex[®] 553 Sorter⁺** automatic sorting systems are reliable and cost-effective solutions designed to optimize logistics operations across a wide range of products and industries.

Our portfolio meets most market demands with standard solutions, ensuring short lead times for both units and spare parts. For specialized applications, we provide comprehensive support, including the design and development of customized solutions tailored to specific requirements.

What are you waiting for? Contact us for a free consultation today!

Company	Contact	Project name
---------	---------	--------------



Unit type		Material	
<input type="checkbox"/>	Carton Boxes	<input type="checkbox"/>	Carton
<input type="checkbox"/>	Parcels	<input type="checkbox"/>	Plastic
<input type="checkbox"/>	Wrapped units	<input type="checkbox"/>	Film
<input type="checkbox"/>	Polybag	<input type="checkbox"/>	Rubber
<input type="checkbox"/>	Trays	<input type="checkbox"/>	Steel
<input type="checkbox"/>		<input type="checkbox"/>	Wood
<input type="checkbox"/>		<input type="checkbox"/>	

Dimensions (mm)			Load (kg)		
	W	L	H	Min	
Min				Max	
Max					

Unit direction		Unit distribution	
<input type="checkbox"/>	LSL	THROUGHPUT - Items per hr	
<input type="checkbox"/>	SSL		
		<input type="text"/>	

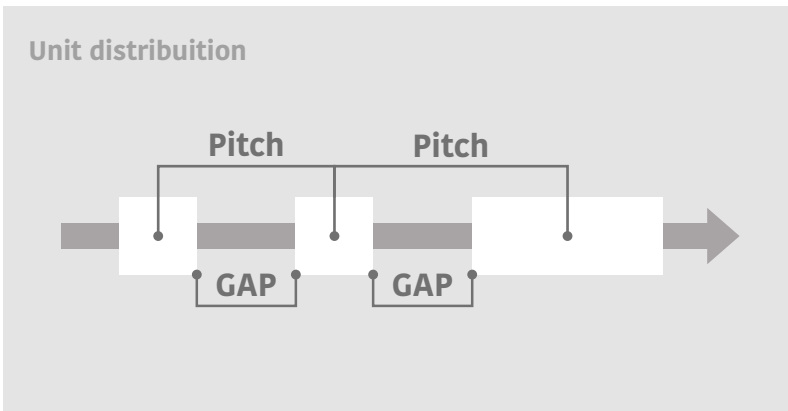

Machine type		*On Request	
<input type="checkbox"/>	Sorter	<input type="checkbox"/>	2:1 Diverger
<input type="checkbox"/>	Infeeder	<input type="checkbox"/>	3:1 Diverger
<input type="checkbox"/>	Bulk Sorter	<input type="checkbox"/>	3:2 Diverger
<input type="checkbox"/>	Aligner	<input type="checkbox"/>	"U" Turn*
<input type="checkbox"/>	1:2 Diverter	<input type="checkbox"/>	Static Turn 90°
<input type="checkbox"/>	1:3 Diverter	<input type="checkbox"/>	Static Turn 180°
<input type="checkbox"/>	2:2 Diverter	<input type="checkbox"/>	Dynamic Turn*
<input type="checkbox"/>	2:3 Diverter	<input type="checkbox"/>	Multi-Sorter*
<input type="checkbox"/>	2:1 Converger	<input type="checkbox"/>	
<input type="checkbox"/>	3:1 Converger	<input type="checkbox"/>	
<input type="checkbox"/>	3:2 Converger	<input type="checkbox"/>	

Different lengths, widths and configurations are available on request, please contact your sales representative.

Do you need help to configure your 553 Sorter+?

Send an email with the filled form and the technical drawings of your layout (.stp/.dwg/.dxf) to info@movexii.com, or contact your sales representative.

You will be contacted by one of our experts for a dedicated support and a customized quote based on your needs.



Movex S.p.A.

Headquarters

Viale Industria, 22
24060 Castelli Calepio (BG)

Logistics Center

Via della Repubblica, 21/E
24060 Castelli Calepio (BG)

Phone +39 035 8359711

info@movexii.com

www.movexii.com

Follow us    

#MovexWorld

Movex worldwide

Movex GmbH

P +49-6204-9375-0

Movex Brasil Ltda

P +55-15-3141-2550

Movex France

P +33-06-21-02-79-15

Movex AG India

P +91-120-4159660-62

Movex UK Ltd.

P +44-77-20678442

Movex Nederland

P +31-630-994850

Movex USA Inc.

P +1-877-401-5377

Movex SA de CV

P +52-1-3318458187

Movex CIS Countries

P +39-348-7769760



movexii.com